

All Seasons Tent Sales

20 x 20 All Trac Frame Tent Set Up Instructions

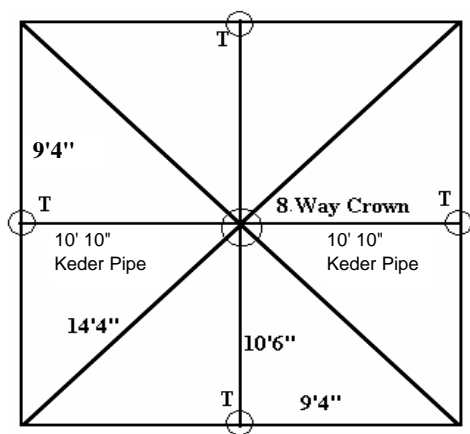

Pipe			
QTY	SIZE	COLOR	Style
4	14' 4"	Red	Hip Rafter
2	10' 10"	Green	Keder
2	10' 6"	Green	Rafter
8	9'4"	White	Spreader
8	7' 8"	Black	Legs

Components	
QTY	Style
1	8 - Way Crown AT
4	Regular Corners
4	Regular T's
8	Ratchets
8	Baseplates
8	Weights / Stakes
40	Tent Pins
Optional Items	
1	Brace Package



8 Way Crown AT Regular T Corner

Pre-Site Inspection- Call your local utility companies prior to installation for any underground obstructions.

1. Layout the frame parts in the estimated location pertaining to the diagram. The spreader pipe is placed out to form the perimeter, and the rafters are laid in the interior location.

2. Start with the 8 way crown. Lay the crown on a flat surface to determine the correct placement, when the crown is on a flat surface the angles that are not touching the ground (every other one) will correlate with the 4 corners. Attach the hip rafters (14'4" red) to the 8 way crown at the angles, that do not touch the ground, by sliding the pole in or over the fitting and lining up the holes in the pole with those in the fitting. Place a pin in the first hole to secure the pole in place. Repeat at all four corners.

3. Attach the poles (10'6" green) to two of the remaining angles of the 8 way crown using the same technique as in step 2. Attach the two 10'10" Keder Pipe to the remaining opposite angles aligning up the 8 way crown with the keder slots.

4. Connect the corner fitting to the hip rafter by sliding the pole in or over the fitting. Line up the hole of the pole with those of the fitting and place a pin.

5. Join the Regular T fitting to the rafters by sliding the pole over the fitting. Line up the hole of the pole with those of the fitting and place a pin.

6. The perimeter is ready for assembly. Connect the Regular T to the corners using the spreaders (9'4" white). Slide the poles over the fittings, line up the holes, and pin the pole and fitting together. When all of the spreaders have been secured in place, the frame will be complete.

7. Slide the keder on the tent through the keder pipe starting at the regular t going up through the 8 way crown, then come back down the other side. Repeat the step for the other end of the tent top.

8. Secure the tent top to the frame by fastening the straps on the inside of the tent at each corner location.

9. Start at one corner and manually lift the frame so that the leg (7'8" black) can slide over the corner fitting. Pin the leg to the fitting. (When raising the tent, raise INTO the wind)

10. Proceed to work your way around the tent putting one leg in at a time until all legs are standing and pinned. Put baseplate under legs and attach 1" ratchets from the "O" rings at the ends of the valance to the baseplates. Tighten loosely.

11. Now that the frame tent is erected, fasten the rest of tent top completely to the frame, using the straps on the inside of the tent. Evenly tighten the ratchets straps on the corners. Make sure the rope through the valance slides smoothly. Make sure that all of the straps are tight and that the tent top is sitting evenly over the frame. Evenly tighten the ratchets straps on the corners. Make sure the rope through the valance slides smoothly.

12. Drive a stake about four feet out from each leg and tie off the rope or ratchet to each leg.

Your tent installation is now complete.

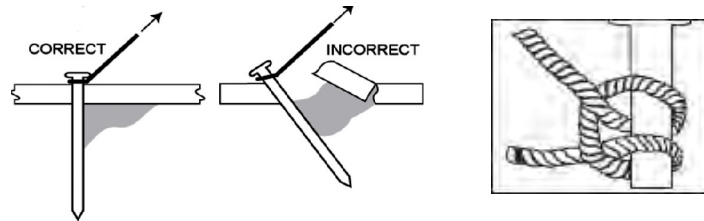

All Seasons Tent Sales

20 x 30 All Trac Frame Tent Set Up Instructions

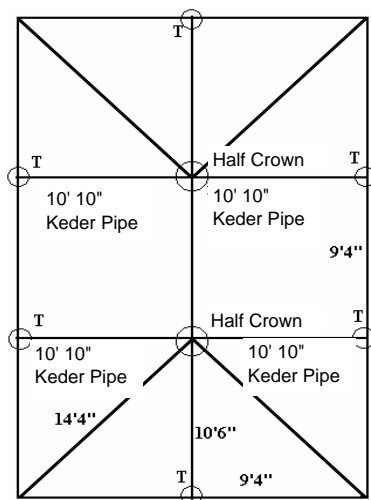

Pipe			
QTY	SIZE	COLOR	Style
4	14' 4"	Red	Hip Rafter
4	10' 10"	Green	Keder
2	10' 6"	Green	Rafter
11	9'4"	White	Spreader
10	7' 8"	Black	Legs

Components	
QTY	Style
2	Half Crown AT
4	Regular Corners
6	Regular T's
10	Ratchets
10	Baseplates
10	Weights / Stakes
52	Tent Pins
Optional Items	
1	Brace Package



Half Crown AT



Regular T



Corner

Pre-Site Inspection- Call your local utility companies prior to installation for any underground obstructions.

1. Layout the frame parts in the estimated location pertaining to the diagram. The spreader pipe is placed out to form the perimeter, and the rafters are laid in the interior location.
2. Start with one of the Half Crowns. Attach the hip rafters (14'4" red) to the Half Crown at the second and fourth points by sliding the pole over the fitting and lining up the holes in the pole with those in the fitting. Place a pin in the first hole to secure the pole in place.
3. Attach the 2 Rafter poles (10'6" green) to points - three and the 10'10" keder pipe to points one and five of the Half Crown using the same technique as in step 2.
4. Attach a spreader (9'4" white) to the Half Crown, and connect it to the other Half Crown.
5. Connect the corner fittings to the hip rafter by sliding the pole over the fitting. Line up the hole of the pole with the first hole of the fitting and place a pin.
6. Join the regular t fittings to the poles by sliding the pole over the fitting. Line up the hole of the pole with the first hole of the fittings and place a pin.
7. The perimeter is ready for assembly. Connect the Regular T to the corners using the spreaders (9'4" white). Slide the poles over the fittings, line up the holes, and pin the pole and fitting together. When all of the spreaders have been secured in place, the frame will be complete.
8. Slide the keder on the tent through the keder pipe starting at the regular t going up through the Half Crown, then come back down the other side. Then slide the middle tent top piece through the middle. Repeat the step for the other end tent top section.
9. Secure the tent top to the frame by fastening the straps on the inside of the tent at each corner location.
10. Start at one corner and manually lift the frame so that the leg (7'8" black) can slide over the corner fitting. Pin the leg to the fitting. (When raising the tent, raise INTO the wind)
11. Proceed to work your way around the tent putting one leg in at a time until all legs are standing and pinned. Put baseplate under legs and attach 1" ratchets from the "O" rings at the ends of the valance to the baseplates. Tighten loosely.

12. Now that the frame tent is erected, fasten the rest of tent top completely to the frame, using the straps on the inside of the tent. Evenly tighten the ratchets straps on the corners. Make sure the rope through the valance slides smoothly. Make sure that all of the straps are tight and that the tent top is sitting evenly over the frame. Evenly tighten the ratchets straps on the corners. Make sure the rope through the valance slides smoothly.

13. Drive a stake about four feet out from each leg and tie off the rope or ratchet to each leg.

Your tent installation is now complete.

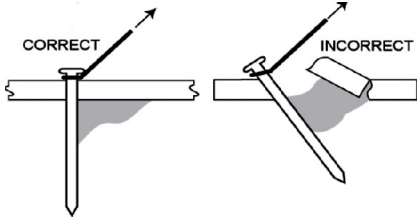
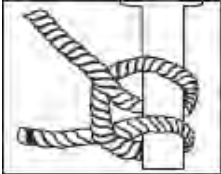

All Seasons Tent Sales

20 x 40 All Trac Frame Tent Set Up Instructions

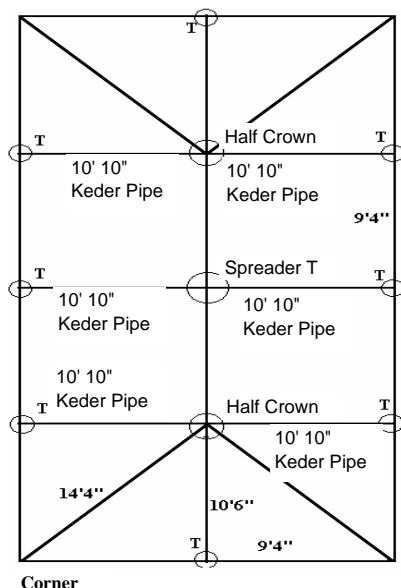

Pipe			
QTY	SIZE	COLOR	Style
4	14' 4"	Red	Hip Rafter
6	10' 10"	Green	Keder
2	10' 6"	Green	Rafter
14	9'4"	White	Spreader
12	7' 8"	Black	Legs

Components	
QTY	Style
2	Half Crown AT
4	Regular Corners
8	Regular T's
1	Spreader T - AT
12	Ratchets
12	Baseplates
12	Weights / Stakes
64	Tent Pins
Optional Items	
1	Spreader Cable
1	Brace Package



Half Crown AT



Regular T



Corner



Spreader T AT

Pre-Site Inspection- Call your local utility companies prior to installation for any underground obstructions.

1. Layout the frame parts in the estimated location pertaining to the diagram. The spreader pipe is placed out to form the perimeter, and the rafters are laid in the interior location.
2. Start with one of the Half Crowns. Attach the hip rafters (14'4" red) to the Half Crown at the second and fourth points by sliding the pole over the fitting and lining up the holes in the pole with those in the fitting. Place a pin in the first hole to secure the pole in place.
3. Attach the 2 Rafter poles (10'6" green) to points - three and the 10'10" keder pipe to points one and five of the Half Crown using the same technique as in step 2.
4. Attach a spreader (9'4" white) to the Half Crown, and connect it to the Spreader T. Connect another spreader (9'4" white) to the second Half Crown from the Spreader T. Repeat steps 2 & 3.
5. Attach the two remaining Keder Pipe (10'10" green) to the Spreader T.
6. Connect the corner fittings to the hip rafter by sliding the pole over the fitting. Line up the hole of the pole with the first hole of the fitting and place a pin.
7. Join the regular t fittings to the poles by sliding the pole over the fitting. Line up the hole of the pole with the first hole of the fittings and place a pin.
8. The perimeter is ready for assembly. Connect the Regular T to the corners using the spreaders (9'4" white). Slide the poles over the fittings, line up the holes, and pin the pole and fitting together. When all of the spreaders have been secured in place, the frame will be complete.
9. Slide the keder on the tent through the keder pipe starting at the regular t going up through the Half Crown, then come back down the other side. Then slide the middle tent top pieces through the middles. Repeat the step for the other end tent top section.
10. Secure the tent top to the frame by fastening the straps on the inside of the tent at each corner location.

11. Start at one corner and manually lift the frame so that the leg (7'8" black) can slide over the corner fitting. Pin the leg to the fitting. (When raising the tent, raise INTO the wind)

12. Proceed to work your way around the tent putting one leg in at a time until all legs are standing and pinned. Put baseplate under legs and attach 1" ratchets from the "O" rings at the ends of the valance to the baseplates. Tighten loosely.

13. Now that the frame tent is erected, fasten the rest of tent top completely to the frame, using the straps on the inside of the tent. Evenly tighten the ratchets straps on the corners. Make sure the rope through the valance slides smoothly. Make sure that all of the straps are tight and that the tent top is sitting evenly over the frame. Evenly tighten the ratchets straps on the corners. Make sure the rope through the valance slides smoothly.

14. Drive a stake about four feet out from each leg and tie off the rope or ratchet to each leg.

Your tent installation is now complete.

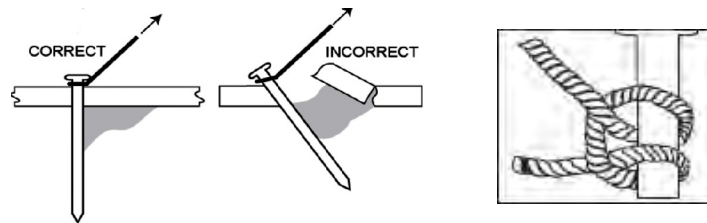

All Seasons Tent Sales

20 x 50 All Trac Frame Tent Set Up Instructions

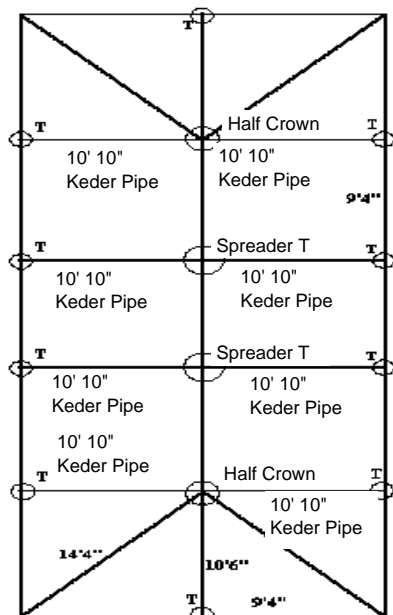

Corner

Pipe			
QTY	SIZE	COLOR	Style
4	14' 4"	Red	Hip Rafter
8	10' 10"	Green	Keder
2	10' 6"	Green	Rafter
17	9' 4"	White	Spreader
14	7' 8"	Black	Legs

Components	
QTY	Style
2	Half Crown AT
4	Regular Corners
10	Regular T's
2	Spreader T- AT
14	Ratchets
14	Baseplates
14	Weights / Stakes
76	Tent Pins
Optional Items	
2	Spreader Cable
1	Brace Package



Half Crown - AT



Regular T



Corner



Spreader T - AT

Pre-Site Inspection- Call your local utility companies prior to installation for any underground obstructions.

1. Layout the frame parts in the estimated location pertaining to the diagram. The spreader pipe is placed out to form the perimeter, and the rafters are laid in the interior location.

2. Start with one of the Half Crowns. Attach the hip rafters (14'4" red) to the Half Crown at the second and fourth points by sliding the pole over the fitting and lining up the holes in the pole with those in the fitting. Place a pin in the first hole to secure the pole in place.

3. Attach the 2 Rafter poles (10'6" green) to points - three and the 10'10" keder pipe to points one and five of the Half Crown using the same technique as in step 2.

4. Attach a spreader (9'4" white) to the Half Crown, and connect it to the Spreader T. Connect another spreader (9'4" white) to the second Half Crown from the Spreader T.

5. Attach the remaining Keder Pipes (10'10" green) to the Spreader T's.

6. Connect the corner fittings to the hip rafter by sliding the pole over the fitting. Line up the hole of the pole with the first hole of the fitting and place a pin.

7. Join the regular t fittings to the poles by sliding the pole over the fitting. Line up the hole of the pole with the first hole of the fittings and place a pin.

8. The perimeter is ready for assembly. Connect the Regular T to the corners using the spreaders (9'4" white). Slide the poles over the fittings, line up the holes, and pin the pole and fitting together. When all of the spreaders have been secured in place, the frame will be complete.

9. Slide the keder on the tent through the keder pipe starting at the regular t going up through the Half Crown, then come back down the other side. Then slide the middle tent top pieces through the middles. Repeat the step for the other end tent top section.

10. Secure the tent top to the frame by fastening the straps on the inside of the tent at each corner location.

11. Start at one corner and manually lift the frame so that the leg (7'8" black) can slide over the corner fitting. Pin the leg to the fitting. (When raising the tent, raise INTO the wind)

12. Proceed to work your way around the tent putting one leg in at a time until all legs are standing and pinned. Put baseplate under legs and attach 1" ratchets from the "O" rings at the ends of the valance to the baseplates. Tighten loosely.

13. Now that the frame tent is erected, fasten the rest of tent top completely to the frame, using the straps on the inside of the tent. Evenly tighten the ratchets straps on the corners. Make sure the rope through the valance slides smoothly. Make sure that all of the straps are tight and that the tent top is sitting evenly over the frame. Evenly tighten the ratchets straps on the corners. Make sure the rope through the valance slides smoothly.

14. Drive a stake about four feet out from each leg and tie off the rope or ratchet to each leg.

Your tent installation is now complete.

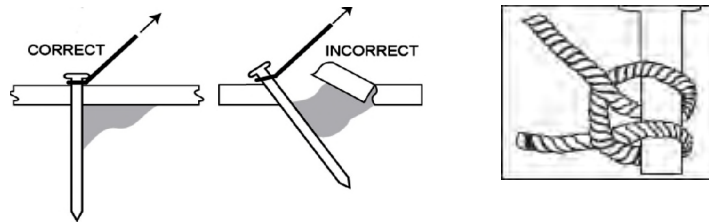

All Seasons Tent Sales

20 x 60 All Trac Frame Tent Set Up Instructions

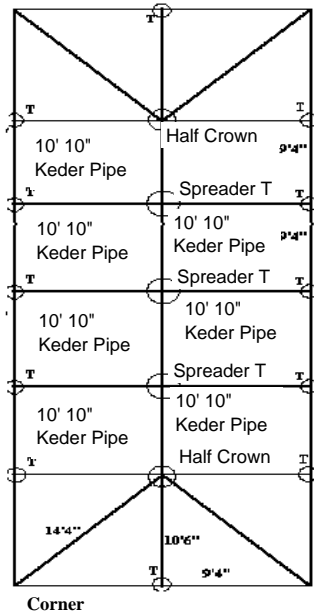

Pipe			
QTY	SIZE	COLOR	Style
4	14' 4"	Red	Hip Rafter
10	10' 10"	Green	Keder
12	10' 6"	Green	Rafter
20	9' 4"	White	Spreader
16	7' 8"	Black	Legs

Components	
QTY	Style
2	Half Crown AT
4	Regular Corners
12	Regular T's
3	Spreader T- AT
16	Ratchets
16	Baseplates
16	Weights / Stakes
88	Tent Pins
Optional Items	
3	Spreader Cable
1	Brace Package



Half Crown AT



Regular T



Corner



Spreader T AT

Pre-Site Inspection- Call your local utility companies prior to installation for any underground obstructions.

1. Layout the frame parts in the estimated location pertaining to the diagram. The spreader pipe is placed out to form the perimeter, and the rafters are laid in the interior location.
2. Start with one of the Half Crowns. Attach the hip rafters (14' 4" red) to the Half Crown at the second and fourth points by sliding the pole over the fitting and lining up the holes in the pole with those in the fitting. Place a pin in the first hole to secure the pole in place.
3. Attach the 2 Rafter poles (10' 6" green) to points - three and the 10' 10" keder pipe to points one and five of the Half Crown using the same technique as in step 2.
4. Attach a spreader (9' 4" white) to the Half Crown, and connect it to the Spreader T. Connect another spreader (9' 4" white) to the second Half Crown from the Spreader T.
5. Attach the remaining Keder Pipes (10' 10" green) to the Spreader T's.
6. Connect the corner fittings to the hip rafter by sliding the pole over the fitting. Line up the hole of the pole with the first hole of the fitting and place a pin.
7. Join the regular t fittings to the poles by sliding the pole over the fitting. Line up the hole of the pole with the first hole of the fittings and place a pin.
8. The perimeter is ready for assembly. Connect the Regular T to the corners using the spreaders (9' 4" white). Slide the poles over the fittings, line up the holes, and pin the pole and fitting together. When all of the spreaders have been secured in place, the frame will be complete.
9. Slide the keder on the tent through the keder pipe starting at the regular t going up through the Half Crown, then come back down the other side. Then slide the middle tent top pieces through the middles. Repeat the step for the other end tent top section.
10. Secure the tent top to the frame by fastening the straps on the inside of the tent at each corner location.

11. Start at one corner and manually lift the frame so that the leg (7'8" black) can slide over the corner fitting. Pin the leg to the fitting. (When raising the tent, raise INTO the wind)

12. Proceed to work your way around the tent putting one leg in at a time until all legs are standing and pinned. Put baseplate under legs and attach 1" ratchets from the "O" rings at the ends of the valance to the baseplates. Tighten loosely.

13. Now that the frame tent is erected, fasten the rest of tent top completely to the frame, using the straps on the inside of the tent. Evenly tighten the ratchets straps on the corners. Make sure the rope through the valance slides smoothly. Make sure that all of the straps are tight and that the tent top is sitting evenly over the frame. Evenly tighten the ratchets straps on the corners. Make sure the rope through the valance slides smoothly.

14. Drive a stake about four feet out from each leg and tie off the rope or ratchet to each leg.

Your tent installation is now complete.

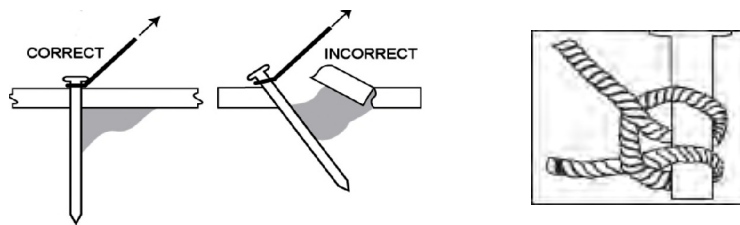

All Seasons Tent Sales

30 x 30 All Trac Frame Tent Set Up Instructions

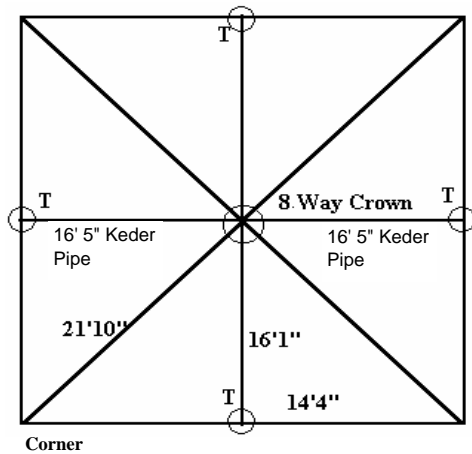

Pipe			
QTY	SIZE	COLOR	Style
4	21'10"	Orange	Hip Rafter
2	16' 5"	Brown	Keder
2	16'1"	Brown	Rafter
8	14'4"	Red	Spreader
8	7' 8"	Black	Legs

Components	
QTY	Style
1	8 Way Crown AT
4	Regular Corners
4	Regular T's
8	Ratchets
8	Baseplates
8	Weights / Stakes
40	Tent Pins
Optional Items	
1	Brace Package



8 Way Crown AT Regular T Corner

Pre-Site Inspection- Call your local utility companies prior to installation for any underground obstructions.

1. Layout the frame parts in the estimated location pertaining to the diagram. The spreader pipe is placed out to form the perimeter, and the rafters are laid in the interior location.
2. Start with the 8 way crown. Lay the crown on a flat surface to determine the correct placement, when the crown is on a flat surface the angles that are not touching the ground (every other one) will correlate with the 4 corners. Attach the hip rafters (21' 10" orange) to the 8 way crown at the angles, that do not touch the ground, by sliding the pole in or over the fitting and lining up the holes in the pole with those in the fitting. Place a pin in the first hole to secure the pole in place. Repeat at all four corners.
3. Attach the poles (16' 1" brown) to two of the remaining angles of the 8 way crown using the same technique as in step 2. Attach the two 16' 5" Keder Pipe to the remaining opposite angles aligning up the 8 way crown with the keder slots.
4. Connect the corner fitting to the hip rafter by sliding the pole in or over the fitting. Line up the hole of the pole with those of the fitting and place a pin.
5. Join the Regular T fitting to the rafters by sliding the pole over the fitting. Line up the hole of the pole with those of the fitting and place a pin.
6. The perimeter is ready for assembly. Connect the Regular T to the corners using the spreaders (14'4" red). Slide the poles over the fittings, line up the holes, and pin the pole and fitting together. When all of the spreaders have been secured in place, the frame will be complete.
7. Slide the keder on the tent through the keder pipe starting at the regular t going up through the 8 way crown, then come back down the other side. Repeat the step for the other end of the tent top.
8. Secure the tent top to the frame by fastening the straps on the inside of the tent at each corner location.
9. Start at one corner and manually lift the frame so that the leg (7'8" black) can slide over the corner fitting. Pin the leg to the fitting. (When raising the tent, raise INTO the wind)

10. Proceed to work your way around the tent putting one leg in at a time until all legs are standing and pinned. Put baseplate under legs and attach 1" ratchets from the "O" rings at the ends of the valance to the baseplates. Tighten loosely.

11. Now that the frame tent is erected, fasten the rest of tent top completely to the frame, using the straps on the inside of the tent. Evenly tighten the ratchets straps on the corners. Make sure the rope through the valance slides smoothly. Make sure that all of the straps are tight and that the tent top is sitting evenly over the frame. Evenly tighten the ratchets straps on the corners. Make sure the rope through the valance slides smoothly.

12. Drive a stake about four feet out from each leg and tie off the rope or ratchet to each leg.

Your tent installation is now complete.

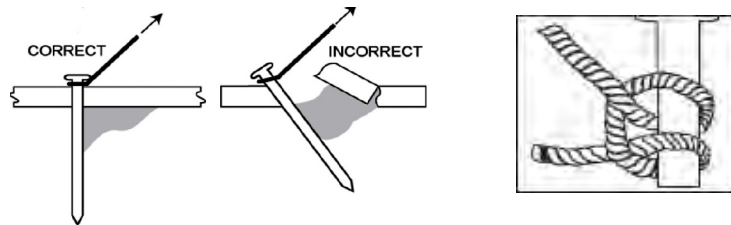

All Seasons Tent Sales

30 x 40 All Trac Tent Set Up Instructions

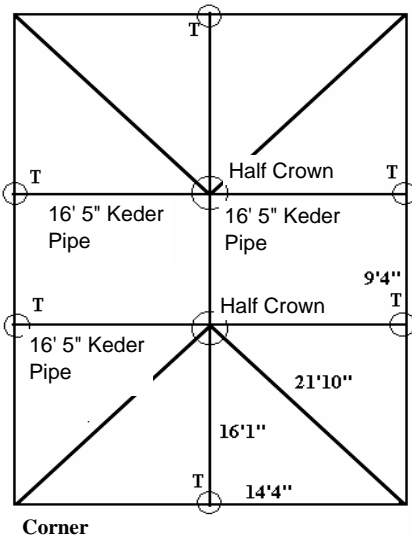

Pipe			
QTY	SIZE	COLOR	Style
4	21'10"	Orange	Hip Rafter
4	16' 5"	Brown	Keder
2	16'1"	Brown	Rafter
8	14'4"	Red	Spreader
3	9'4"	White	Spreader
10	7' 8"	Black	Legs

Components	
QTY	Style
2	Half Crown AT
4	Regular Corners
6	Regular T's
10	Weights / Stakes
10	Ropes
52	Tent Pins
10	Ratchets
10	Baseplates
Optional Items	
1	Brace Package
1	Spreader Cable



Half Crown AT



Regular T



Corner

Pre-Site Inspection- Call your local utility companies prior to installation for any underground obstructions.

1. Layout the frame parts in the estimated location pertaining to the diagram. The spreader pipe is placed out to form the perimeter, and the rafters are laid in the interior location.
2. Start with one of the Half Crowns. Attach the hip rafters (21' 10" orange) to the Half Crown at the second and fourth points by sliding the pole over the fitting and lining up the holes in the pole with those in the fitting. Place a pin in the first hole to secure the pole in place.
3. Attach the 2 Rafter poles (16' 1" brown) to points - three and the 16' 5" keder pipe to points one and five of the as in step 2.
4. Attach a spreader (9'4" white) to the Half Crown, and connect it to the other Half Crown.
5. Connect the corner fittings to the hip rafter by sliding the pole over the fitting. Line up the hole of the pole with the first hole of the fitting and place a pin.
6. Join the regular t fittings to the poles by sliding the pole over the fitting. Line up the hole of the pole with the first hole of the fittings and place a pin.
7. The perimeter is ready for assembly. Connect the Regular T's to the corners using the spreaders (14'4" red) and connect the regular t's to the regular t's using the spreaders (9'4" white). Slide the poles over the fittings, line up the holes, and pin the pole and fitting together. When all of the spreaders have been secured in place, the frame will be complete.
8. Slide the keder on the tent through the keder pipe starting at the regular t going up through the Half Crown, then come back down the other side. Then slide the middle tent top pieces through the middles. Repeat the step for the other end tent top section.
9. Secure the tent top to the frame by fastening the straps on the inside of the tent at each corner location.

10. Start at one corner and manually lift the frame so that the leg (7'8" black) can slide over the corner fitting. Pin the leg to the fitting. (When raising the tent, raise INTO the wind)

11. Proceed to work your way around the tent putting one leg in at a time until all legs are standing and pinned. Put baseplate under legs and attach 1" ratchets from the "O" rings at the ends of the valance to the baseplates. Tighten loosely.

12. Now that the frame tent is erected, fasten the rest of tent top completely to the frame, using the straps on the inside of the tent. Evenly tighten the ratchets straps on the corners. Make sure the rope through the valance slides smoothly. Make sure that all of the straps are tight and that the tent top is sitting evenly over the frame. Evenly tighten the ratchets straps on the corners. Make sure the rope through the valance slides smoothly.

13. Drive a stake about four feet out from each leg and tie off the rope or ratchet to each leg.

Your tent installation is now complete.

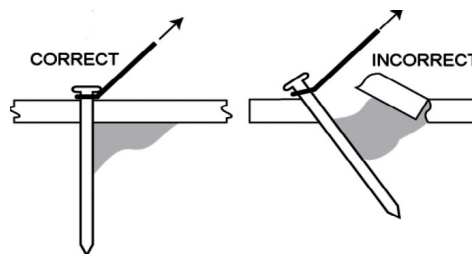
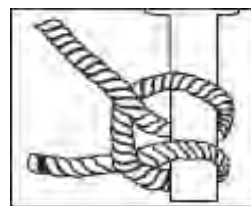

All Seasons Tent Sales

30 x 45 All Trac Frame Tent Set Up Instructions

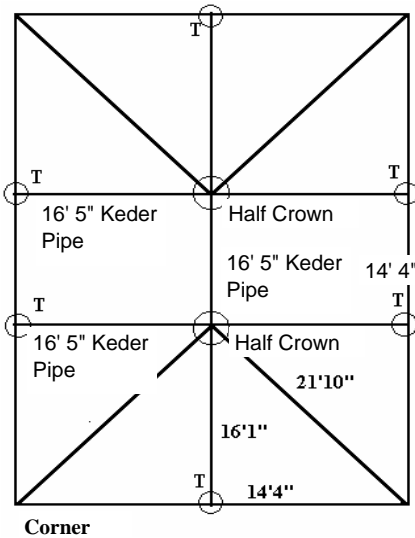

Pipe			
QTY	SIZE	COLOR	Style
4	21'10"	Orange	Hip Rafter
4	16' 5"	Brown	Keder
2	16'1"	Brown	Rafter
8	14'4"	Red	Spreader
3	9'4"	White	Spreader
10	7' 8"	Black	Legs

Components	
QTY	Style
2	Half Crown AT
4	Regular Corners
6	Regular T's
10	Ratchets
10	Baseplates
10	Weights / Stakes
52	Tent Pins
Optional Items	
1	Brace Package
1	Spreader Cable



Half Crown



Regular T



Corner

Pre-Site Inspection- Call your local utility companies prior to installation for any underground obstructions.

1. Layout the frame parts in the estimated location pertaining to the diagram. The spreader pipe is placed out to form the perimeter, and the rafters are laid in the interior location.
2. Start with one of the Half Crowns. Attach the hip rafters (21' 10" orange) to the Half Crown at the second and fourth points by sliding the pole over the fitting and lining up the holes in the pole with those in the fitting. Place a pin in the first hole to secure the pole in place.
3. Attach the 2 Rafter poles (16' 1" brown) to points - three and the 16' 5" keder pipe to points one and five of the as in step 2.
4. Attach a spreader (14'4" red) to the Half Crown, and connect it to the other Half Crown.
5. Connect the corner fittings to the hip rafter by sliding the pole over the fitting. Line up the hole of the pole with the first hole of the fitting and place a pin.
6. Join the regular t fittings to the poles by sliding the pole over the fitting. Line up the hole of the pole with the first hole of the fittings and place a pin.
7. The perimeter is ready for assembly. Connect the Regular T's to the corners using the spreaders (14'4" red) and connect the regular t's to the regular t's using the spreaders (14'4" red). Slide the poles over the fittings, line up the holes, and pin the pole and fitting together. When all of the spreaders have been secured in place, the frame will be complete.
8. Slide the keder on the tent through the keder pipe starting at the regular t going up through the Half Crown, then come back down the other side. Then slide the middle tent top pieces through the middles. Repeat the step for the other end tent top section.

9. Secure the tent top to the frame by fastening the straps on the inside of the tent at each corner location.

10. Start at one corner and manually lift the frame so that the leg (7'8" black) can slide over the corner fitting. Pin the leg to the fitting. (When raising the tent, raise INTO the wind)

11. Proceed to work your way around the tent putting one leg in at a time until all legs are standing and pinned. Put baseplate under legs and attach 1" ratchets from the "O" rings at the ends of the valance to the baseplates. Tighten loosely.

12. Now that the frame tent is erected, fasten the rest of tent top completely to the frame, using the straps on the inside of the tent. Evenly tighten the ratchets straps on the corners. Make sure the rope through the valance slides smoothly. Make sure that all of the straps are tight and that the tent top is sitting evenly over the frame. Evenly tighten the ratchets straps on the corners. Make sure the rope through the valance slides smoothly.

13. Drive a stake about four feet out from each leg and tie off the rope or ratchet to each leg.

Your tent installation is now complete.

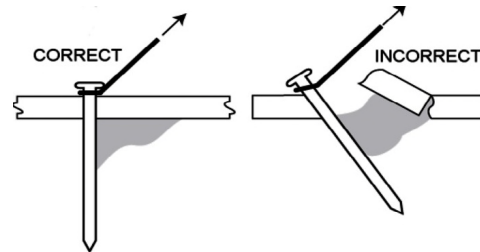
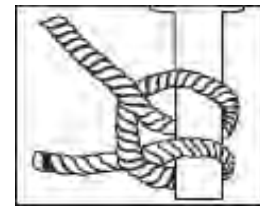

All Seasons Tent Sales

30 x 50 All Track Frame Tent Set Up Instructions

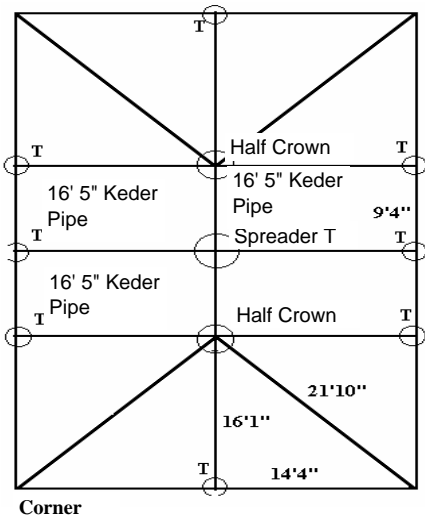

Pipe			
QTY	SIZE	COLOR	Style
4	21'10"	Orange	Hip Rafter
6	16' 5"	Brown	Keder
2	16'1"	Brown	Rafter
8	14'4"	Red	Spreader
6	9'4"	White	Spreader
12	7' 8"	Black	Legs

Components	
QTY	Style
2	Half Crown AT
4	Regular Corners
8	Regular T's
1	Spreader T -AT
12	Weights / Stakes
12	Ropes
64	Tent Pins
12	Ratchets
12	Baseplates
Optional Items	
1	Brace Package
2	Spreader Cables



Half Crown AT



Regular T



Corner



Spreader T AT

Pre-Site Inspection- Call your local utility companies prior to installation for any underground obstructions.

1. Layout the frame parts in the estimated location pertaining to the diagram. The spreader pipe is placed out to form the perimeter, and the rafters are laid in the interior location.
2. Start with one of the Half Crowns. Attach the hip rafters (21' 10" orange) to the Half Crown at the second and fourth points by sliding the pole over the fitting and lining up the holes in the pole with those in the fitting. Place a pin in the first hole to secure the pole in place.
3. Attach the 2 Rafter poles (16' 1" brown) to points - three and the 16' 5" keder pipe to points one and five of the Half Crown using the same technique as in step 2.
4. Attach a spreader (9'4" white) to the Half Crown, and connect it to the Spreader T. Connect another spreader (9'4" white) to the second Half Crown from the Spreader T.
5. Attach the remaining Keder Pipe (16' 5" brown) to the Spreader T's.
6. Connect the corner fittings to the hip rafter by sliding the pole over the fitting. Line up the hole of the pole with the first hole of the fitting and place a pin.
7. Join the regular t fittings to the poles by sliding the pole over the fitting. Line up the hole of the pole with the first hole of the fittings and place a pin.
8. The perimeter is ready for assembly. Connect the Regular T to the corners using the spreaders (14'4" red). Slide the poles over the fittings, line up the holes, and pin the pole and fitting together. Use the white 9' 4" spreaders in the middle. When all of the spreaders have been secured in place, the frame will be complete.
9. Slide the keder on the tent through the keder pipe starting at the regular t going up through the Half Crown, then come back down the other side. Then slide the middle tent top pieces through the middles. Repeat the step for the other end tent top section.

10. Secure the tent top to the frame by fastening the straps on the inside of the tent at each corner location.

11. Start at one corner and manually lift the frame so that the leg (7'8" black) can slide over the corner fitting. Pin the leg to the fitting. (When raising the tent, raise INTO the wind)

12. Proceed to work your way around the tent putting one leg in at a time until all legs are standing and pinned. Put baseplate under legs and attach 1" ratchets from the "O" rings at the ends of the valance to the baseplates. Tighten loosely.

13. Now that the frame tent is erected, fasten the rest of tent top completely to the frame, using the straps on the inside of the tent. Evenly tighten the ratchets straps on the corners. Make sure the rope through the valance slides smoothly. Make sure that all of the straps are tight and that the tent top is sitting evenly over the frame. Evenly tighten the ratchets straps on the corners. Make sure the rope through the valance slides smoothly.

14. Drive a stake about four feet out from each leg and tie off the rope or ratchet to each leg.

Your tent installation is now complete.

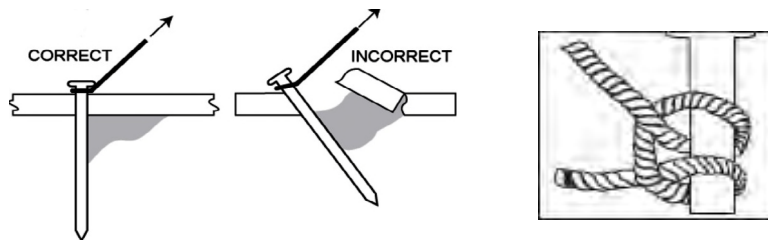

All Seasons Tent Sales

30 x 60 All Trac Frame Tent Set Up Instructions

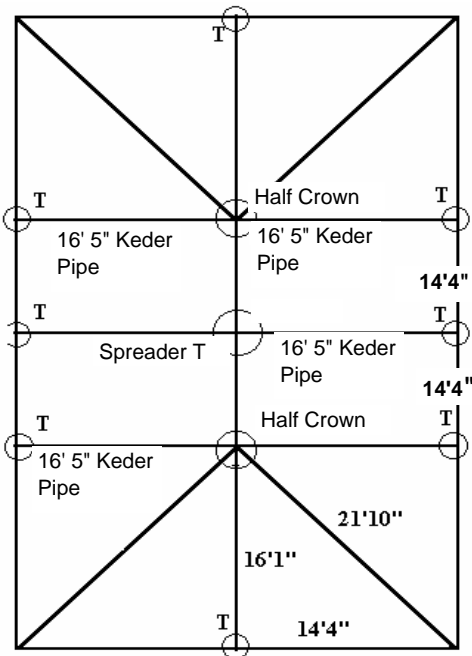

Pipe			
QTY	SIZE	COLOR	Style
4	21'10"	Orange	Hip Rafter
6	16' 5"	Brown	Keder
2	16'1"	Brown	Rafter
14	14'4"	Red	Spreader
12	7' 8"	Black	Legs

Components	
QTY	Style
2	Half Crown AT
4	Regular Corners
8	Regular T's
1	Spreader T-AT
12	Ratchets
12	Baseplates
12	Weights / Stakes
64	Tent Pins
Optional Items	
1	Brace Package
3	Spreader Cables



Half Crown AT



Regular T



Corner



Spreader T AT

Pre-Site Inspection- Call your local utility companies prior to installation for any underground obstructions.

1. Layout the frame parts in the estimated location pertaining to the diagram. The spreader pipe is placed out to form the perimeter, and the rafters are laid in the interior location.
2. Start with one of the Half Crowns. Attach the hip rafters (21' 10" orange) to the Half Crown at the second and fourth points by sliding the pole over the fitting and lining up the holes in the pole with those in the fitting. Place a pin in the first hole to secure the pole in place.
3. Attach the 2 Rafter poles (16' 1" brown) to points - three and the 16' 5" keder pipe to points one and five of the Half Crown using the same technique as in step 2.
4. Attach a spreader (14'4" red) to the Half Crown, and connect it to the Spreader T. Connect another spreader (14'4" red) to the second Half Crown from the Spreader T.
5. Attach the two remaining keder poles (16' 5" brown) to the Spreader T.
6. Connect the corner fittings to the hip rafter by sliding the pole over the fitting. Line up the hole of the pole with the first hole of the fitting and place a pin.
7. Join the regular t fittings to the poles by sliding the pole over the fitting. Line up the hole of the pole with the first hole of the fittings and place a pin.

8. The perimeter is ready for assembly. Connect the Regular T's to the corners using the spreaders (14'4" red) and connect the regular t's to the regular t's using the spreaders (14'4" red). Slide the poles over the fittings, line up the holes, and pin the pole and fitting together. When all of the spreaders have been secured in place, the frame will be complete.

9. Slide the keder on the tent through the keder pipe starting at the regular t going up through the Half Crown, then come back down the other side. Then slide the middle tent top pieces through the middles. Repeat the step for the other end tent top section.

10. Secure the tent top to the frame by fastening the straps on the inside of the tent at each corner location.

11. Start at one corner and manually lift the frame so that the leg (7'8" black) can slide over the corner fitting. Pin the leg to the fitting. (When raising the tent, raise INTO the wind)

12. Proceed to work your way around the tent putting one leg in at a time until all legs are standing and pinned. Put baseplate under legs and attach 1" ratchets from the "O" rings at the ends of the valance to the baseplates. Tighten loosely.

13. Now that the frame tent is erected, fasten the rest of tent top completely to the frame, using the straps on the inside of the tent. Evenly tighten the ratchets straps on the corners. Make sure the rope through the valance slides smoothly. Make sure that all of the straps are tight and that the tent top is sitting evenly over the frame. Evenly tighten the ratchets straps on the corners. Make sure the rope through the valance slides smoothly.

14. Drive a stake about four feet out from each leg and tie off the rope or ratchet to each leg.

Your tent installation is now complete.

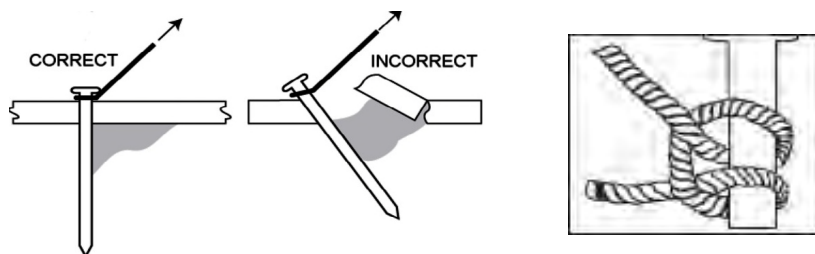

All Seasons Tent Sales

40 x 40 Contempo Frame Tent Set Up Instructions

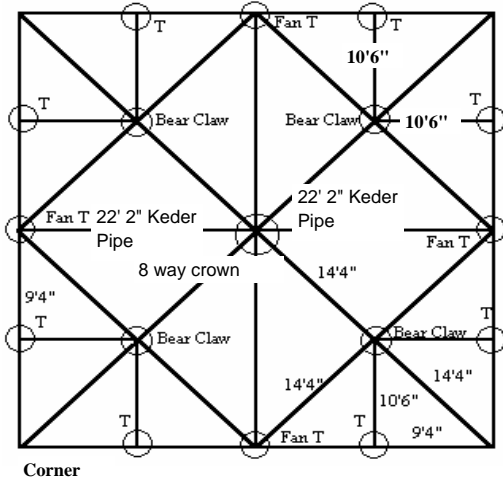

Pipe			
QTY	SIZE	COLOR	Style
2	22' 2"	Orange	Keder
2	21'10"	Orange	Rafter
16	14'4"	Red	Hip Rafter
8	10'6"	Green	Corner Rafter
16	14'4"	Red	Spreader
16	7' 8"	Black	Legs

Components	
QTY	Style
1	8 Way Crown AT
4	Regular Corners
8	Regular T's
4	Bear Claws
4	Fan T
16	Ratchets
16	Baseplates
16	Weights / Stakes
104	Tent Pins
Optional Items	
1	Brace Package

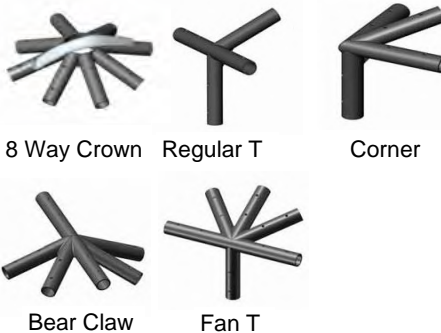

Pre-Site Inspection- Call your local utility companies prior to installation for any underground obstructions.

1. Layout the frame parts in the estimated location pertaining to the diagram. The spreader pipe is placed out to form the perimeter, and the rafters are laid in the interior location.

2. Start with the 8 way crown. Lay the crown on a flat surface to determine the correct placement, when the crown is on a flat surface the angles that are not touching the ground (every other one) will correlate with the 4 corners. Attach the hip rafters (14'4" red) to the 8 way crown at angle not touching the ground by sliding the pole over the fitting and lining up the holes in the pole with those in the fitting. Place a pin in the first hole to secure the pole in place. Repeat at all four corners.

3. Attach the poles (21' 10" orange) to two of the remaining angles of the 8 way crown using the same technique as in step 2. Attach the two 22' 2" Keder Pipe to the remaining opposite angles aligning up the 8 way crown with the keder slots.

4. Attach the Bear Claw fittings to the 4 hip rafter (14'4" red), at point 6, by sliding the pole over the fitting. Line up the hole of the pole with those of the fitting and place a pin. Attach hip rafters (14'4" red) to the Bear Claw at points 1, 3, and 5. Attach corner rafters (10'6" green) to the Bear Claw fitting at points 2 and 4.

5. Attach the corner fitting to the hip rafter (point 3 only) by sliding the pole over the fitting. Line up the hole of the pole with those of the fitting and place a pin. Attach the Fan T to the rafters (21'10" orange) and to the hip rafters (points 1 & 5).

6. Join the regular t fittings to the corner poles (10'6" green) by sliding the pole over the fitting. Line up the hole of the pole with those of the fittings and place a pin.

7. The perimeter is ready for assembly. Connect the regular t's to the corners and fan t's using the spreaders (9'4" white). Slide the poles over the fittings, line up the holes, and pin the pole and fitting together. When all of the spreaders have been secured in place, the frame will be complete.
 8. Slide the keder on the tent through the keder pipe starting at the regular t going up through the 8 way crown, then come back down the other side. Repeat the step for the other end of the tent top.
 9. Secure the tent top to the frame by fastening the straps on the inside of the tent at each corner location.
 10. Start at one corner and manually lift the frame so that the leg (7'8" black) can slide over the corner fitting. Pin the leg to the fitting. (When raising the tent, raise INTO the wind)
 11. Proceed to work your way around the tent putting one leg in at a time until all legs are standing and pinned. Put baseplate under legs and attach 1" ratchets from the "O" rings at the ends of the valance to the baseplates. Tighten loosely.
 12. Now that the frame tent is erected, fasten the rest of tent top completely to the frame, using the straps on the inside of the tent. Evenly tighten the ratchets straps on the corners. Make sure the rope through the valance slides smoothly. Make sure that all of the straps are tight and that the tent top is sitting evenly over the frame. Evenly tighten the ratchets straps on the corners. Make sure the rope through the valance slides smoothly.
 13. Drive a stake about four feet out from each leg and tie off the rope or ratchet to each leg.
- Your tent installation is now complete.

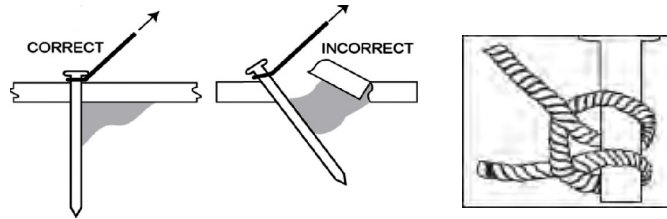

All Seasons Tent Sales

40 x 60 All Trac Frame Tent Set Up Instructions

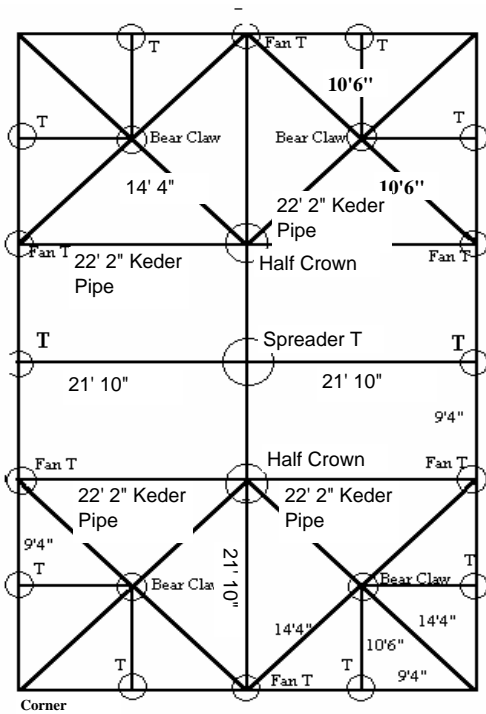

Pipe			
QTY	SIZE	COLOR	Style
4	22' 2"	Orange	Keder
4	21' 10"	Orange	Rafter
16	14' 4"	Red	Hip Rafter
8	10' 6"	Green	Corner Rafter
22	14' 4"	Red	Spreader
20	7' 8"	Black	Legs

Components	
QTY	Style
2	Half Crowns AT
4	Regular Corners
10	Regular T's
1	Spreader T
4	Bear Claws
6	Fan T
20	Ratchets
20	Baseplates
20	Weights / Stakes
136	Tent Pins
Optional Items	
1	Brace Package
2	Spreader Cables



Half Crown AT



Regular T



Corner



Bear Claw



Fan T



Spreader T

Pre-Site Inspection- Call your local utility companies prior to installation for any underground obstructions.

1. Layout the frame parts in the estimated location pertaining to the diagram. The spreader pipe is placed out to form the perimeter, and the rafters are laid in the interior location.
2. Start with one of the Half Crowns. Attach the hip rafters (21' 10" orange) to the Half Crown at the third point, and attach the Keder pipe to the one and five points. Place a pin in the first hole to secure the pole in place.
3. Attach the hip rafter (14' 4" red) to the remaining points of the Half Crown using the same technique as in step 2.
4. Attach a spreader (9' 4" white) to the Half Crown, and connect it to the Spreader T. Attach another spreader (9' 4" white) from the Spreader T to the Half Crown. Attach rafters (21' 10" orange) to the Spreader T. Repeat steps 2 & 3.
5. Attach the Bear Claw fitting to the 4 hip poles (14' 4" red) by sliding the pole over the fitting. Line up the hole of the pole with those of the fitting and place a pin. Attach hip rafters (14' 4" red) to the Bear Claw fitting at points 1, 3, and 5.
6. Attach corner poles (10' 6" green) to the Bear Claw fitting at points 2 and 4.
7. Attach the corner fitting to the hip rafter (point 3 only) by sliding the pole over the fitting. Line up the hole of the pole with those of the fitting and place a pin. Attach the Fan T's to the rafters (21' 10" orange) and to the hip rafters (points 1 & 5).

8. Join the Regular T fittings to the corner poles (10'6" green) by sliding the pole over the fitting. Line up the hole of the pole with those of the fittings and place a pin.

9. The perimeter is ready for assembly. Connect the Regular T's to the corners and Fan T's using the spreaders (9'4" white). Slide the poles over the fittings, line up the holes, and pin the pole and fitting together. When all of the spreaders have been secured in place, the frame will be complete.

10. Slide the keder on the tent through the keder pipe starting at the regular t going up through the Half Crown, then come back down the other side. Then slide the middle tent top pieces through the middles. Repeat the step for the other end tent top section.

11. Secure the tent top to the frame by fastening the straps on the inside of the tent at each corner location.

12. Start at one corner and manually lift the frame so that the leg (7'8" black) can slide over the corner fitting. Pin the leg to the fitting. (When raising the tent, raise INTO the wind)

13. Proceed to work your way around the tent putting one leg in at a time until all legs are standing and pinned. Put baseplate under legs and attach 1" ratchets from the "O" rings at the ends of the valance to the baseplates. Tighten loosely.

14. Now that the frame tent is erected, fasten the rest of tent top completely to the frame, using the straps on the inside of the tent. Evenly tighten the ratchets straps on the corners. Make sure the rope through the valance slides smoothly. Make sure that all of the straps are tight and that the tent top is sitting evenly over the frame. Evenly tighten the ratchets straps on the corners. Make sure the rope through the valance slides smoothly.

15. Drive a stake about four feet out from each leg and tie off the rope or ratchet to each leg.

Your tent installation is now complete.

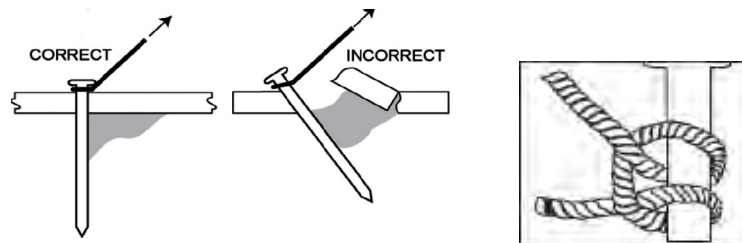

All Seasons Tent Sales

40 x 80 All Trac Frame Tent Set Up Instructions

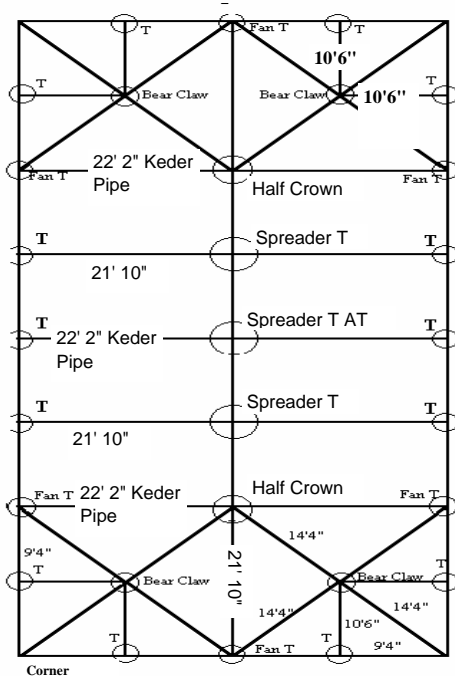

Pipe			
QTY	SIZE	COLOR	Style
6	22' 2"	Orange	Keder
6	21'10"	Orange	Rafter
16	14'4"	Red	Hip Rafter
8	10'6"	Green	Corner Rafter
28	14'4"	Red	Spreader
24	7' 8"	Black	Legs

Components	
QTY	Style
2	Half Crowns AT
4	Regular Corners
14	Regular T's
2	Spreader T
1	Spreader T AT
4	Bear Claws
6	Fan T
24	Ratchets
24	Baseplates
24	Weights / Stakes
164	Tent Pins
Optional Items	
1	Brace Package
3	Spreader Cables

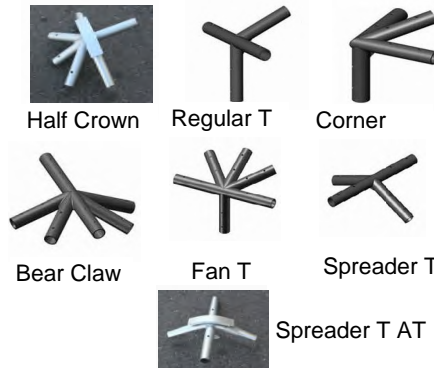

Pre-Site Inspection- Call your local utility companies prior to installation for any underground obstructions.

1. Layout the frame parts in the estimated location pertaining to the diagram. The spreader pipe is placed out to form the perimeter, and the rafters are laid in the interior location.
2. Start with one of the Half Crowns. Attach the hip rafters (21' 10" orange) to the Half Crown at the third point, and attach the Keder pipe to the one and five points. Place a pin in the first hole to secure the pole in place.
3. Attach the hip rafter (14'4" red) to the remaining points of the Half Crown using the same technique as in step 2.
4. Attach a spreader (9'4" white) to the Half Crown, and connect it to the Spreader T. Attach another spreader (9' 4" white) from the Spreader T to the Spreader T- AT and repeat for a total of 3 Spreader T's. The last Spreader T will connect to the second Half Crown. Attach rafters (21'10" orange) to the Spreader T's one and three. Attach the keder pipe to the middle spreader T.
5. Attach the Bear Claw fitting to the 4 hip poles (14'4" red) by sliding the pole over the fitting. Line up the hole of the pole with those of the fitting and place a pin. Attach hip rafters (14'4" red) to the Bear Claw fitting at points 1, 3, and 5.
6. Attach corner poles (10'6" green) to the Bear Claw fitting at points 2 and 4.
7. Attach the corner fitting to the hip rafter (point 3 only) by sliding the pole over the fitting. Line up the hole of the pole with those of the fitting and place a pin. Attach the Fan T's to the rafters (21'10" orange) and to the hip rafters (points 1 & 5).

8. Join the Regular T fittings to the corner poles (10'6" green) by sliding the pole over the fitting. Line up the hole of the pole with those of the fittings and place a pin.
9. The perimeter is ready for assembly. Connect the Regular T's to the corners and Fan T's using the spreaders (9'4" white). Slide the poles over the fittings, line up the holes, and pin the pole and fitting together. When all of the spreaders have been secured in place, the frame will be complete.
10. Slide the keder on the tent through the keder pipe starting at the regular t going up through the Half Crown, then come back down the other side. Then slide the middle tent top pieces through the middles. Repeat the step for the other end tent top section.
11. Secure the tent top to the frame by fastening the straps on the inside of the tent at each corner location.
12. Start at one corner and manually lift the frame so that the leg (7'8" black) can slide over the corner fitting. Pin the leg to the fitting. (When raising the tent, raise INTO the wind)
13. Proceed to work your way around the tent putting one leg in at a time until all legs are standing and pinned. Put baseplate under legs and attach 1" ratchets from the "O" rings at the ends of the valance to the baseplates. Tighten loosely.
14. Now that the frame tent is erected, fasten the rest of tent top completely to the frame, using the straps on the inside of the tent. Evenly tighten the ratchets straps on the corners. Make sure the rope through the valance slides smoothly. Make sure that all of the straps are tight and that the tent top is sitting evenly over the frame. Evenly tighten the ratchets straps on the corners. Make sure the rope through the valance slides smoothly.
15. Drive a stake about four feet out from each leg and tie off the rope or ratchet to each leg.

Your tent installation is now complete.

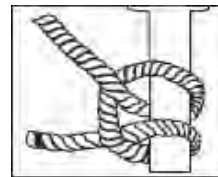
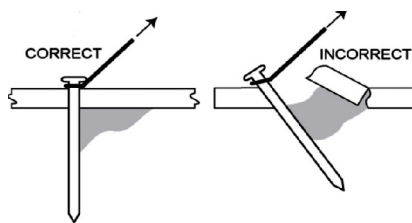

All Seasons Tent Sales

40 x 100 All Trac Frame Tent Set Up Instructions

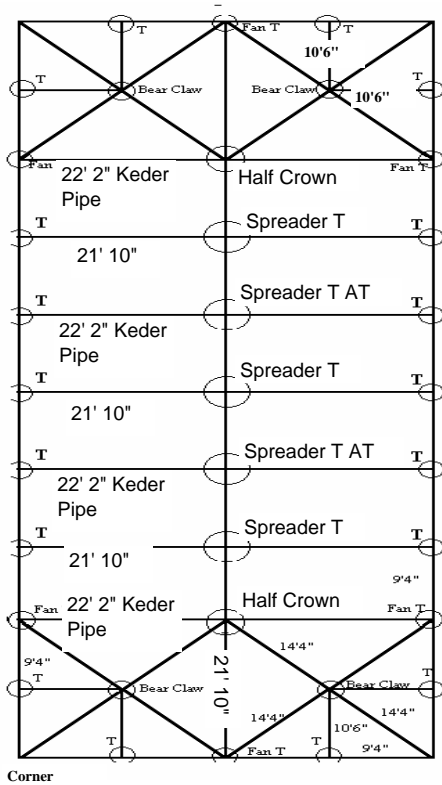

Pipe			
QTY	SIZE	COLOR	Style
8	22' 2"	Orange	Keder
8	21' 10"	Orange	Rafter
16	14' 4"	Red	Hip Rafter
8	10' 6"	Green	Corner Rafter
34	14' 4"	Red	Spreader
28	7' 8"	Black	Legs

Components	
QTY	Style
2	Half Crowns
4	Regular Corners
18	Regular T's
3	Spreader T
2	Spreader T - AT
4	Bear Claws
6	Fan T
28	Ratchets
28	Baseplates
28	Weights / Stakes
180	Tent Pins
Optional Items	
1	Brace Package
4	Spreader Cables



Half Crown AT



Regular T



Corner



Bear Claw



Fan T



Spreader T



Spreader T AT

Pre-Site Inspection- Call your local utility companies prior to installation for any underground obstructions.

1. Layout the frame parts in the estimated location pertaining to the diagram. The spreader pipe is placed out to form the perimeter, and the rafters are laid in the interior location.
2. Start with one of the Half Crowns. Attach the hip rafters (21' 10" orange) to the Half Crown at the third point, and attach the Keder pipe to the one and five points. Place a pin in the first hole to secure the pole in place.
3. Attach the hip rafter (14' 4" red) to the remaining points of the Half Crown using the same technique as in step 2.
4. Attach a spreader (9' 4" white) to the Half Crown, and connect it to the Spreader T. Attach another spreader (9' 4" white) from the Spreader T to the Spreader T - AT and repeat for a total of 5 Spreader T's. The last Spreader T will connect to the second Half Crown. Attach rafters (21' 10" orange) to the Spreader T's one and three. Attach the keder pipe to the second and fourth spreader T - AT's.
5. Attach the Bear Claw fitting to the 4 hip poles (14' 4" red) by sliding the pole over the fitting. Line up the hole of the pole with those of the fitting and place a pin. Attach hip rafters (14' 4" red) to the Bear Claw fitting at points 1, 3, and 5.
6. Attach corner poles (10' 6" green) to the Bear Claw fitting at points 2 and 4.
7. Attach the corner fitting to the hip rafter (point 3 only) by sliding the pole over the fitting. Line up the hole of the pole with those of the fitting and place a pin. Attach the Fan T's to the rafters (21' 10" orange) and to the hip rafters (points 1 & 5).

8. Join the Regular T fittings to the corner poles (10'6" green) by sliding the pole over the fitting. Line up the hole of the pole with those of the fittings and place a pin.

9. The perimeter is ready for assembly. Connect the Regular T's to the corners and Fan T's using the spreaders (9'4" white). Slide the poles over the fittings, line up the holes, and pin the pole and fitting together. When all of the spreaders have been secured in place, the frame will be complete.

10. Slide the keder on the tent through the keder pipe starting at the regular t going up through the Half Crown, then come back down the other side. Then slide the middle tent top pieces through the middles. Repeat the step for the other end tent top section.

11. Secure the tent top to the frame by fastening the straps on the inside of the tent at each corner location.

12. Start at one corner and manually lift the frame so that the leg (7'8" black) can slide over the corner fitting. Pin the leg to the fitting. (When raising the tent, raise INTO the wind)

13. Proceed to work your way around the tent putting one leg in at a time until all legs are standing and pinned. Put baseplate under legs and attach 1" ratchets from the "O" rings at the ends of the valance to the baseplates. Tighten loosely.

14. Now that the frame tent is erected, fasten the rest of tent top completely to the frame, using the straps on the inside of the tent. Evenly tighten the ratchets straps on the corners. Make sure the rope through the valance slides smoothly. Make sure that all of the straps are tight and that the tent top is sitting evenly over the frame. Evenly tighten the ratchets straps on the corners. Make sure the rope through the valance slides smoothly.

15. Drive a stake about four feet out from each leg and tie off the rope or ratchet to each leg.

Your tent installation is now complete.

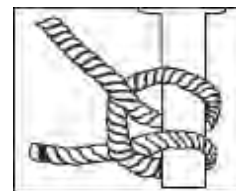
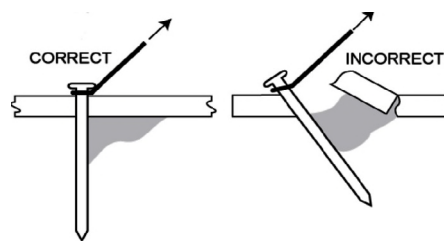

This document was created with Win2PDF available at <http://www.win2pdf.com>.
The unregistered version of Win2PDF is for evaluation or non-commercial use only.
This page will not be added after purchasing Win2PDF.